

## D Montageanleitung Schnappschloss systemeQ-4686

### 1. Vorbereitung Türflügel

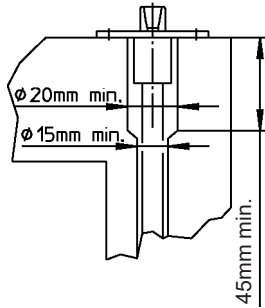

### 2. Befestigung

Blechschaube ST 4,2 x 13mm DIN 7982  
Schraube M5 x 12mm DIN 965



Blindnietmutter M5  
**nicht im Lieferumfang enthalten**

### 3. Schnappschlossachse senkrecht über Achse des Gewindelochs (Gangflügelschloss)

systemeQ-S20\*,  
systemeQ S20-ESC,  
systemeQ S20-SL-ESC

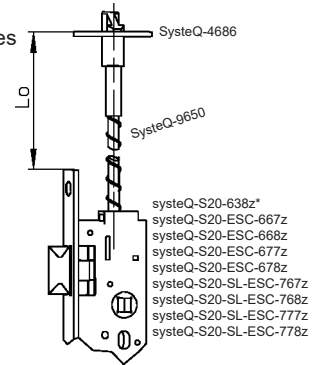

### 4. Ermittlung der Stangenlänge - Stange kürzen

Art. Nr.	Stulp 285mm
systemeQ-S20-638z*, systemeQ-S20-ESC-667z systemeQ-S20-ESC-668z, systemeQ-S20-ESC-677z systemeQ-S20-ESC-678z, systemeQ-S20-SL-ESC-767z systemeQ-S20-SL-ESC-768z systemeQ-S20-SL-ESC-777z systemeQ-S20-SL-ESC-778z	L = Lo + 54mm



### 5. Montage Schnappfalle - Stange eindrehen

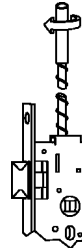

### 6a. Montage - Aufsetzen der Schnappfalle - Bohren des Durchgangloches

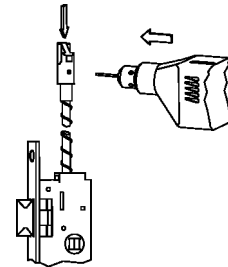

### 6b. Montage - Spannhülse einschlagen - Stange rausdrehen

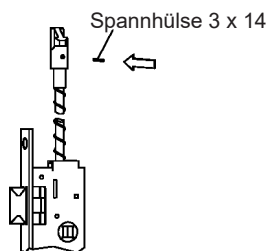

### 7. Montieren und Justieren der Schnappfalle 1. Gangflügelschloss montieren

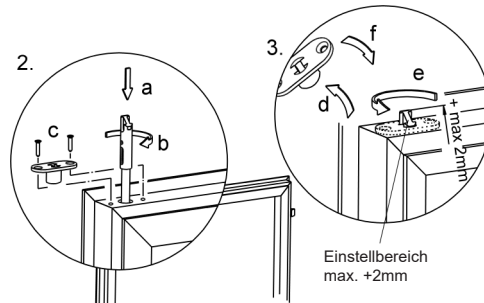

### 8. Bei großer Türluft Stulp unterfüttern

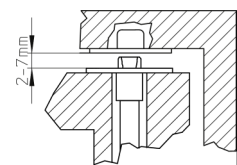

**Achtung:**  
Schließblech im Bereich des  
Fallenaufschlags anfasen!

### 9. Ausrichtung des Schnappschlusses

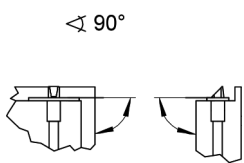

### 10. Funktionsprobe

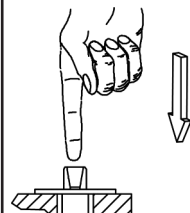

Bei Verklemmung  
siehe Abb. 3 und 9

\* Dieses Schloss entspricht nicht EN 179 / EN 1125  
Zum Einbau des Schnappschlusses dürfen nur Artikel verwendet werden, welche in der Montageanleitung beschrieben sind.  
Die Anleitungen bzw. Anweisungen müssen vom Monteur an den Benutzer weitergegeben und von diesem bis zum Ende der Nutzung aufbewahrt werden.  
Technische Änderungen vorbehalten

- Die Flügel und der Rahmen des Türelementes müssen aus ausreichend stabilen Werkstoffen (z.B. geschweißter Stahl oder Aluminiumprofil) bestehen. Die Verformung des Türelementes ist so gering zu halten, dass die Funktion der Verschlusselemente nicht beeinträchtigt wird.
- Es dürfen nur Elemente erstellt werden, deren Flügelhöhe von 3500 mm, Flügelbreite von 1600 mm und Flügelgewicht von 400 kg nicht überschritten wird.

Scherstellen gegeben. Deshalb ist es wichtig, dass zwischen der Außenseite des Knaufs bis zum Hebelarm des Stangengriffs, oder eines anderen auslösenden Beschlagteils, ein Freiraum von mindestens 10 mm sichergestellt wird.  
4. Bei der Montage der Treibriegelstange muss das Anzugsdrehmoment 5-8 Nm betragen.

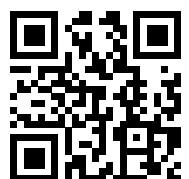
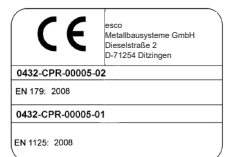

## Installation instructions for snap latch systeQ-4686



### 1. Preparation of door leaf

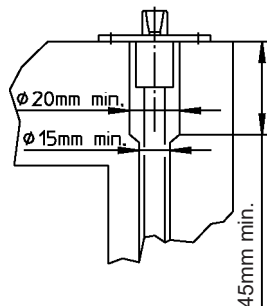

### 2. Fixing

self tapping screw ST 4,2 x 13mm DIN 7982    screw M5 x 12mm DIN 965

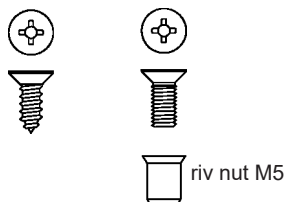

not included

### 3. Align axle of snap latch perpendicularly above axle of tapped hole (active leaf lock)

systeQ-S20\*,  
systeQ S20-ESC,  
systeQ S20-SL-ESC

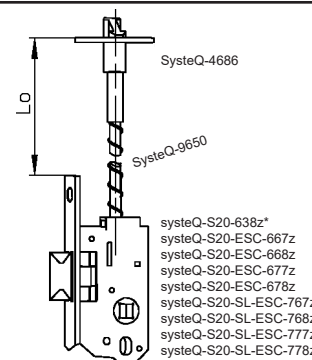

### 4. Determining the length (L) of the shoot bolt - cut shoot bolt

Art. Nr.	Forend 285mm
systeQ-S20-638z*, systeQ-S20-ESC-667z, systeQ-S20-ESC-668z, systeQ-S20-ESC-677z, systeQ-S20-ESC-678z, systeQ-S20-SL-ESC-767z, systeQ-S20-SL-ESC-768z, systeQ-S20-SL-ESC-777z, systeQ-S20-SL-ESC-778z	L = Lo + 54mm



### 5. Assembly of snap latch - turn shoot bolt in

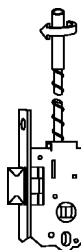

### 6a. Assembly

- put on snap latch
- drill through the hole

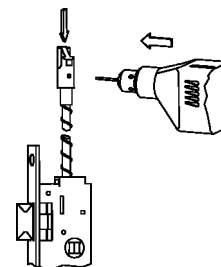

### 6b. Assembly

- drive in adaptor sleeve
- turn shoot bolt out

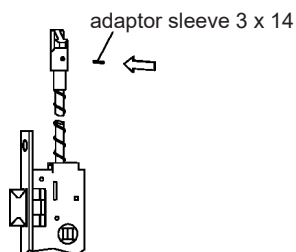

### 7. Assembly and setting of snap latch

#### 1. Insert active leaf lock

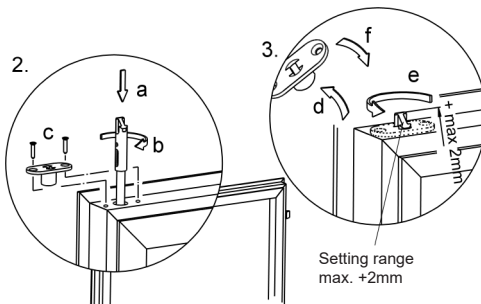

### 8. Shim forend if there is more door clearance

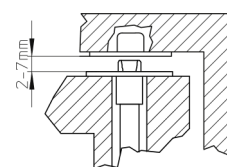

**Attention:**  
Chamfer striking plate where latch bolt hits!

### 9. Align snap latch

90°

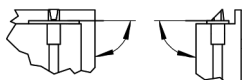

### 10. Function test

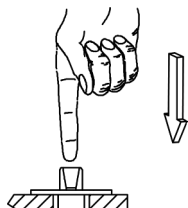

If jammed see point 3 and 9

\* These lock do not correspond to EN 179 / 1125

Only use articles which are describe in these instructions. These instructions and directions should be passed to the end user by the installer and keep reliably up to the working life.

Leaving technical details.

- The leaves and the frame of the door element must be made of sufficiently sturdy materials (e.g. welded steel or aluminum profile). Make sure that any deformation in the door element is kept to a minimum to ensure that the locking element will work properly.
- The leaf dimensions in the door elements produced may not exceed 3500 mm in height, 1600 mm in width or 400 kg in weight.

- ring points. That's why it's important to keep a clearance of at least 10mm between the outside of the knob up to the lever arm or other activating fitting.
- During mounting the shoot bolts the locking torque has to be 5-8 Nm.

3. Key-operated half- or double cylinders as well as mechanical or electronic knob cylinder (with or without key operation) have no effect on the lock's panic door function (even when the key is inserted). Only the knob of a mechanical or electronic knob cylinder can affect the push bar's functioning, depending on the knob shape and size. Some push bars pose the risk of pinch or shea-

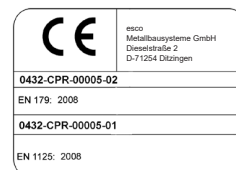

<http://www.esco-Zertifikate.de>  
performance description and certificates